



**2024**



# *Innovate. Design. Manufacture.*

Located in Virginia Beach, VA since 2007, S&S Precision's focus has remained steadfast on solving end-user problems and developing their gear. People are the end state for us. Dreaming creatively about problems and developing those dreams into products is unbelievably satisfying to us. This is the feeling that drives us. Further, if we can't be on the frontline, then we want to do everything possible to make it better for those who are. We develop real innovation for real warriors. *We'll innovate, you fight.*



## ***Product Catalog 2024***

# 2024 EVENTS

**WEPTAC** – January 10-11 | Nellis AFB

**SHOT Show** – January 23-26 | Las Vegas, NV

**JCAS Symposium** – TBD | Virginia Beach, VA

**Enforce Tac** – February 26-28 | Nuremberg, Germany

**SHOP Show** – February 6-7 | Colorado

**TTPOA** – April 25-26 | Round Rock, TX

**SOF Week** – TBD | Tampa, FL

**Rampart Range Day** – May 24 | Canada

**Eurosatory** – June 17-21 | Paris

**NTOA** – TBD | Aurora, Colorado

**MSPO** – TBD | Poland

**AUSA** – October 14-16 | Washington, DC

**IACP** – TBD | San Diego, CA

**SHOP Show Raeford** – October 8 | Raeford, NC

**FOR THE LATEST UPDATES  
FOLLOW US ONLINE**

[SANDSPRECISION.COM/EVENTS](https://sandsprecision.com/events)

# CONTENTS

## ILLUMINATION

[Helmet & Weapon Systems](#) 1

## CARRIERS

[PlateFrames & Harnesses](#) 11

## MARITIME

[Diving & Accessories](#) 21

## LOADOUTS

[Packs & Pouches](#) 27

## BELT SYSTEMS

[Adapters & Accessories](#) 35

## RETENTION SYSTEMS

[Gear & Weapon Accessories](#) 39

## NAVGEAR

[Navigation & Accessories](#) 53

## S & S PRECISION

[OEM Capabilities & NSN Index](#) 61



ssprecision



sandsprecision



S & S Precision



# ILLUMINATION





### MARK SB

The MARK SB is the latest illumination beacon by S&S Precision, aimed at providing the Military & Law Enforcement community and the commercial market a versatile marker with the ability to replace the 2032 lithium batteries. It can be attached by the use of Velcro on the baseplate or a clip to secure to any 1" webbing or MOLLE. It is waterproof to 100'. The MARK SB is available in two different models; Tactical and Adventure.

#### TACTICAL MODEL:

- IR Low
- IR High
- Green Overt Steady
- Green Overt Steady with White flash overlay

#### ADVENTURE MODEL:

- 4 Pre-programmed modes:
- 8 color options: Red, Orange, Yellow, Green, Blue, White, Purple and Pink





The Manta Strobe™ is a multi-spectrum light emitter optimized for Military & Law Enforcement operations. Our goal is clear: keep it simple for the end user, provide the highest level of performance through “select” electronic components combined with smart programming for highest output and extended battery life.

- Primary overt LEDs are visible beyond the FAR105.19 requirements (3 statute miles)
- One-handed intuitive operation with vibrating feedback
- Other spectrums available upon request
- Aluminum Tailcap is standard on all models
- Zero accidental overt light discharge
- Tool-less battery replacement (CR123A battery not included)
- Manta Webbing Adapter (MWA) included
- IPX8 - Waterproof up to 150 ft
- IFF, CID
- Weight with battery: 2.12 oz
- MWA weight: 0.4 oz
- Patent #: US 8485686, US 8882292, US 10024527
- NSN available — see NSN Index page 65

Tailcap & MWA



Light Color Options



CUSTOM PROGRAMMING AVAILABLE



USER INSTRUCTIONS  
[sspgear.com/  
 end-user-instructions](http://sspgear.com/end-user-instructions)



## V-LITE™ ..... MULTI-COLOR

The V-Lite™ Multi-Color gives all the same versatility as the V-Lite™ Multi-Mode with 3 colors built in to choose.

FUNCTIONS:

- On / Off Blue
- On / Off Red
- On / Off Green
- Alternating from Green to Red
- Alternating from Red to Blue



## V-LITE™ ..... MULTI-MODE

The V-Lite™ Multi-Mode is 1 single color with multiple programmed functions at the click of one button. Available in 9 colors.

PROGRAMMABLE FUNCTIONS:

- On / Off
- Blink / Off
- On / Blink / Off
- 1/4, 1/2, 3/4, Full Output





## M-AX MOUNT™

- Powerful helmet mounted flashlight
- Positions the flashlight up and above the helmet rail
- Lightweight, low profile design
- Small assembly with multi-axis range of motion
- Mounts to the Gentex/Ops-Core, Team Wendy (2.0 & 3.0 Rail) and Galvion Helmets
- Compatible with all SureFire® 3V components
- Compatible with all B.E. Meyers® KIJ1 components
- Mount sold individually or with the SureFire® 3V headlamp and tail cap
- Patent #: US 8727556

## TASK LIGHT HELMET MOUNT KIT

- Provides a dedicated mount to run the Princeton Tec MPLS that can attach both the SPH-4 and the HGU-56 flight helmets

### 3 MOUNTING OPTIONS





### IFM CAM

- Materials: 7075/6061 aluminum, and 4140 steel
- Tool-less mounting system
- Compatible with all SureFire® 3V components
- IFM available with or without SureFire components
- Left or Right IFM options available
- Patent #: US 9562550



### INTEGRATED FLASHLIGHT MOUNTS (IFM)

- The IFM positions the flashlight into a fixed offset position and reduces the overall profile of the forward hand guard
- Avoid protruding lights, and snag hazards
- Partnered with SureFire®, the IFM delivers a low profile offset position in a robust machined housing with the most advanced tactical lighting technology in the world

### IFM RIGID

- Materials: 6061 aluminum
- IFM Rigid 6V available
- Compatible with SureFire® 3V and 6V components
- 3V and 6V available with or without SureFire® light
- IFM available with or without SureFire components
- Left or Right IFM options available
- Patent #: US 8727556



**MOUNTING OPTIONS:** The diagram depicts the offset mount positions while facing the barrel of an unloaded weapon. The IFM Rigid can be mounted on the 12, 3, 6 and 9 o'clock positions.

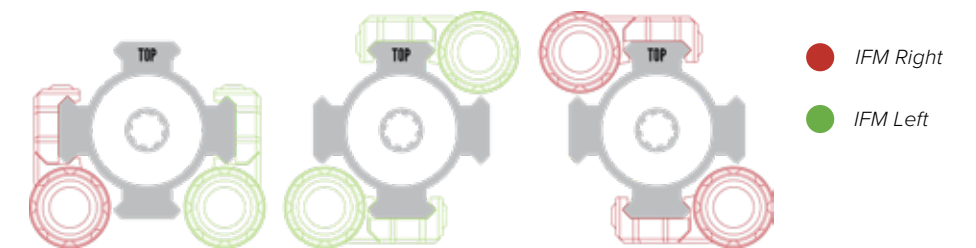





# CARRIERS

PlateFrames & Harnesses



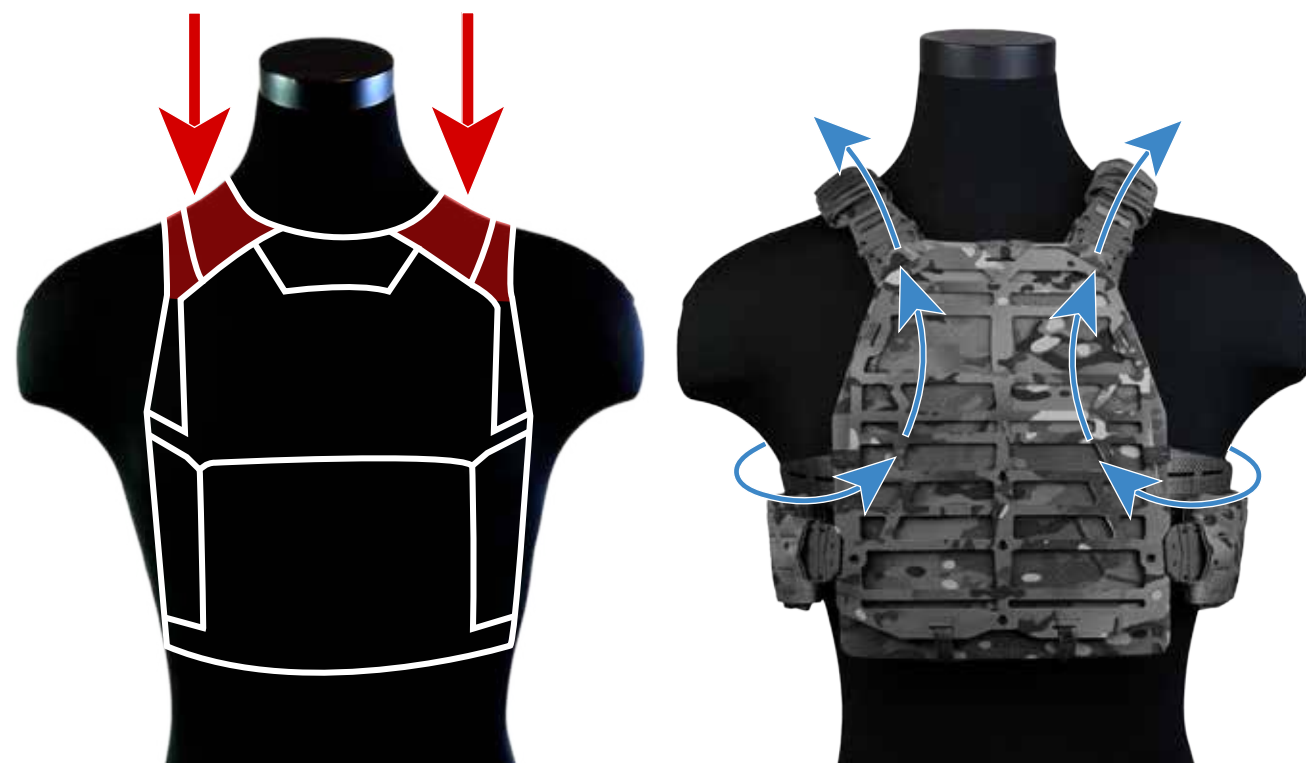

The Auto-Fit Cummerbund (Patent #: US 10605574) distributes the max loadout across/around the torso, reducing the weight on the trapezius muscles

### ADJUSTABLE TENSION SYSTEM



- Auto-Fit Technology
- On the fly tension adjustability
- Thermoplastic composite reinforced to minimize tactical load shift/sag
- Minimalist footprint - 2" height
- External MOLLE/PALS field
- 3" Expansion travel per side
- Internal Velcro loop field
- E-Buckle or Polymer Buckle



- Auto-Fit Technology
- On the fly tension adjustability
- Thermoplastic composite reinforced to minimize tactical load shift/sag
- Minimalist footprint - 2" height
- External & internal MOLLE/PALS field
- 3" Expansion travel per side
- E-Buckle or Polymer Buckle

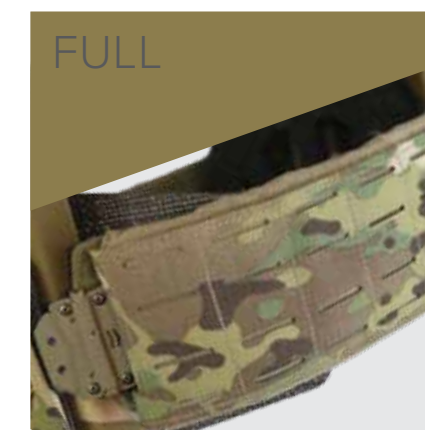

- Auto-Fit Technology
- On the fly tension adjustability
- Thermoplastic composite reinforced to minimize tactical load shift/sag
- Height: 3"
- External & internal MOLLE/PALS field
  - Secured via Velcro hook and loop backed panels
  - Allows users to mount accessories and pouches that attach via Velcro
- Internal/external cable routing keepers
- 3" Expansion travel per side
- E-Buckle or Polymer Buckle
- Integrated Internal/External Cable Routing Keepers
- Velcro Mounted Pouch/Accessory Compatible

All 3 cummerbunds are configurable with an E-Buckle or Polymer Buckle. Buckle configuration dependent upon carrier or harness.



- ### E-BUCKLE
- Low profile – 0.405" thick
  - Stainless steel and aluminum construction
  - Dual actuated side release
  - Textured locking buttons



- ### POLYMER BUCKLE
- Impact modified thermoplastic
  - Ideal for maritime environments
  - Push or pull release



BACK VIEW

Shown with armor and SOCs

PLATEFRAME-MODULAR™

- Optimize comfort, performance and modularity
- Customized to fit any 10x12, shooter/swimmer, (E)SAPI, and Velocity Systems ULV plates
- Reinforced shoulder pads
- Drag handle exceeds 300 pounds in testing
- Includes closed cell comfort foam
- Four metal E-Buckles (Polymer Buckle option available)
- Equipped with adjustable Auto-Fit Cumberbund™
- Patent #: US 10605574



PLATEFRAME-REDUX™

- Out-performs all other carriers in its class in performance, comfort, and modularity
- A single layer of semi-rigid composite material with laser-cut MOLLE/PALS slots
- Two Polymer Quick Release Buckles
- Equipped with adjustable Auto-Fit Cumberbund™
- Comfort foam and radio wings sold separately
- Patent #: US 10605574



BACK VIEW

Shown with armor and SOCs



LIGHT AUTO-FIT CUMMERBUND



HEAVY AUTO-FIT CUMMERBUND



BACK VIEW

*ADVANCED  
TACTICAL HARNESS™*

- Lightweight harness for holding mission critical gear in a variety of environments
- Scalability into a full armor configuration allows the end user to only require one system for all mission sets
- Custom front panel with attachment points of any two Push-to-Talks and dedicated sets of rubber bands to attach tourniquets
- Constructed of lightweight, hydrophobic materials
- Four polymer quick-release buckles for rapid donning/doffing
- Includes closed cell comfort foam
- Equipped with adjustable Auto-Fit Cummerbund™
- Patent #: US 10605574

*MARITIME  
TACTICAL HARNESS™*

- Designed for surface and subsurface maritime operations
- Scalability into a full armor configuration allows the end user to only require one system for all mission sets
- Constructed of lightweight, hydrophobic materials
- Four polymer quick-release buckles for rapid donning/doffing
- Includes closed cell comfort foam
- Equipped with adjustable Auto-Fit Cummerbund™
- Patent #: US 10605574



BACK VIEW



CHEST RIG-MODULAR™

- Designed to be a monolithic, semi-rigid load-bearing structure
- Scalability into a full armor configuration allows the end user to only require one system for all mission sets
- Flexible yet stable platform with the adaptability to carry a variety of loadouts
- Ultra-lightweight, durable rig that can be customized to fit any mission set
- Abdominal panel fits up to 2 radios and 3 rifle magazines
- Low-profile back harness
- Manufactured using hydrophobic materials
- Includes closed cell comfort foam



BACK VIEW

ADDITIONAL FEATURE



Optional laser cut MOLLE/PALS Admin Panel accepts a variety of pouches and smart devices

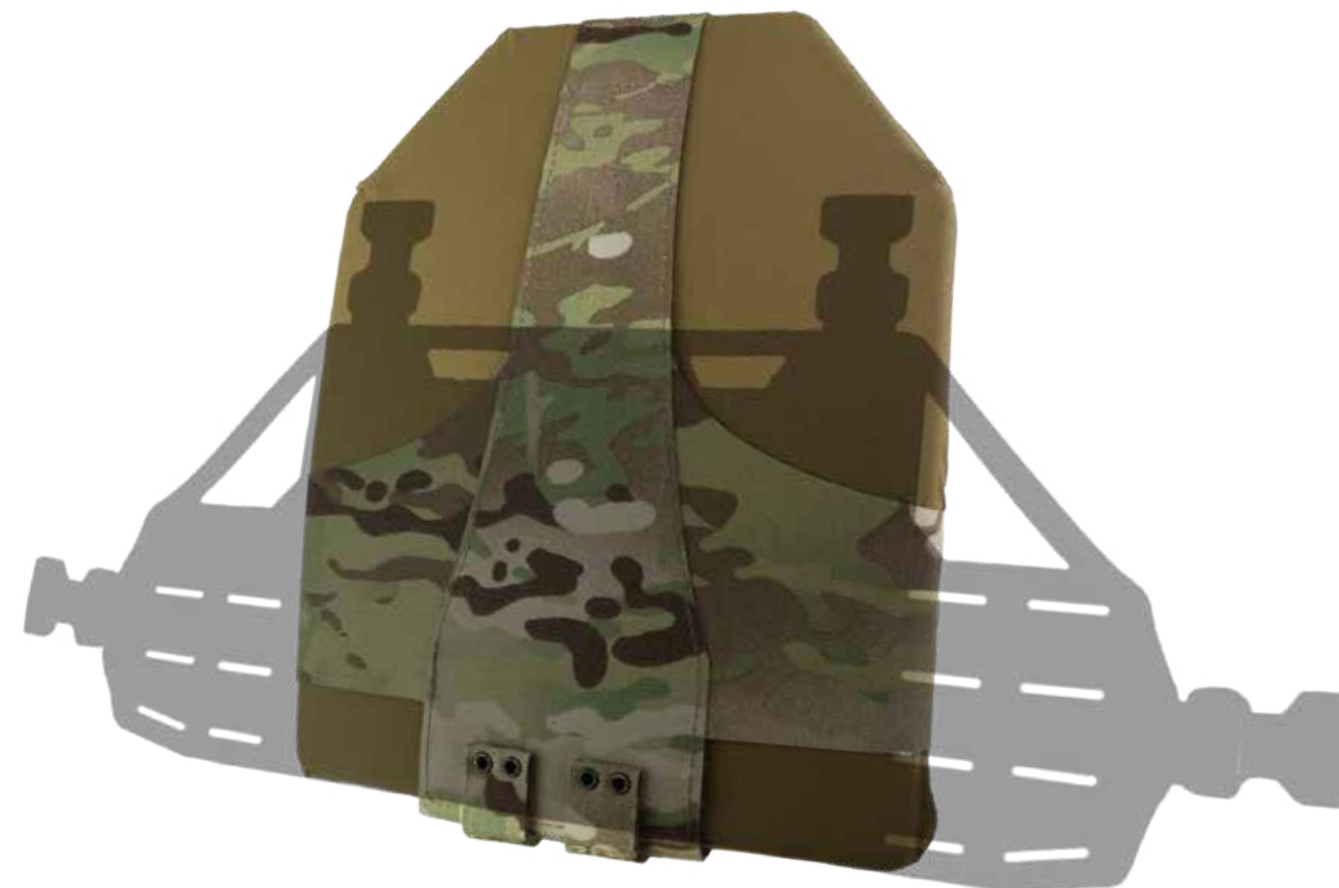

ARMOR HARNESS

Allows the operator to add armor plates to S&S Precision Harnesses (CRM™, ATH™, MTH™) without having to change loadout configurations.



**ARITIME**  
Diving & Accessories



## ..... LIFTR™ 40

2 lbs, 2 oz

### 40 LBS OF POSITIVE LIFT AT THE SURFACE

The LiftR™ 40 is ANU Approved (1.118) with 45G CO<sub>2</sub> cartridge to depth of 50 fsw

- Flotation system used in surface and subsurface operations
- Floats user in a face-up operation
- Low profile, self-packing system
- Can be worn with or without armor
- multiple attachment system accessories
- Auto or manual inflation options available
- Fits most plate carriers
- Manual air dump/deflation
- Compatible with power inflator



## LIFTR™ 80 .....

2 lbs, 12 oz

### 80 LBS OF POSITIVE LIFT AT THE SURFACE

The LiftR™ 80 is ANU Approved (1.1.20) with 86G CO<sub>2</sub> cartridge to depth of 190 fsw

- Flotation system used in surface and subsurface operations
- Floats user in a face-up operation
- Low profile, self-packing system
- Can be worn with or without armor
- multiple attachment system accessories
- Auto or manual inflation options available
- Fits most plate carriers
- Manual air dump/deflation
- Compatible with power inflator

The LiftR™ is available in both 40 and 80 lb lift options with either auto or manual inflation. Additionally, the LiftR™ is equipped with an oral inflation tube or re-inflation. Since the LiftR™ is designed to help float the user in a face-up operation, it allows the user to manually dump air or deflate the unit quickly with a built-in manual air dump/over-inflation valve. The LiftR™ uses standard CO<sub>2</sub> cartridges and are easily able to be replaced by the user.

## CREATE A CUSTOM DIVE SYSTEM FOR YOUR NEXT MISSION

Choose a PlateFrame or Harness (MTH™ shown)



Add the Rebreather Attachment Kit (RAK) (Connects to a Rebreather of your choosing)



Choose & add a LiftR™ (LiftR™ 40 shown)

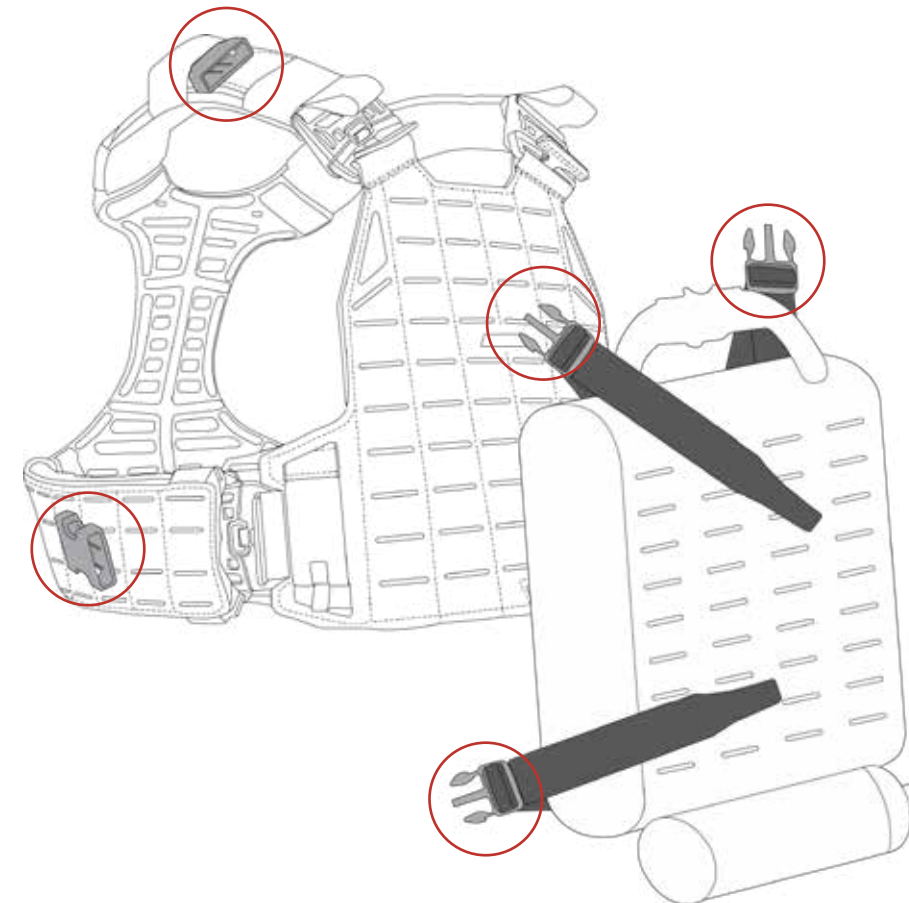

The **RAK-Rebreather Attachment Kit** establishes an adjustable four point connection between a rebreather and all S&S Precision Plate Carriers.

- Includes Neck and Waist Strap Adapters, as well as, shoulder and cummerbund adapters, as well as, rebreather conversion straps that connect via four 1.5" wide side-release buckles
- Attach directly to the rebreather or the rebreather's cover via a 1.5" tri-glide and allows the user to adjust the rebreather's position on the carrier/harness
- Side release buckle system allows the user to quickly don or doff the rebreather



## DRY BAGS .....

- Durable Dry Bags built for rugged waterborne operations
- YKK Aquaseal welded seams
- MOLLE/PALS mounting system
- The 8"x 10" Dry Bag has a MOLLE/PALS field on the front of the bag
- Oral inflate/deflate valve with cover, which can be used to adjust the pouch's buoyancy
- Sizes available: 8" x 10" and 6" x 7"
- S&S Precision and Watershed - A Strategic Alliance

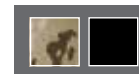

Shown with optional 3 Mag insert



## .....FIN RETENTION

Designed to carry fins securely using a removable side release buckle and bungee keeper.





# LOADOUTS

Packs & Pouches

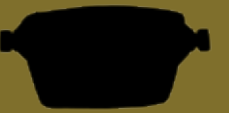

Expanded



Collapsed

### TECHNICAL FEATURES

- Streamlined multipurpose pack designed to maximize loadout capability
- Capable of collapsing from a full 10L volume to a low-profile flat pack in seconds
- Laser-cut MOLLE/PALS allows for maximum loadout customization
- 4 ports of cables, antenna and hydration hose (2 shoulder/2 waist)



### ADAPTS TO ANY USER'S APPLICATION



Compatible with the S&S PF-M™ using its integrated Rapid Attachment Panel (RAP) technology



Configurable to any MOLLE/PALS carrier using integrated MOLLE/PALS straps and hanging tabs (compatible with the S&S PF-R™)



Pack M with radios and battery



### ONE SIZE FITS ALL

*KIT INCLUDES: PACK, HOLSTER, POUCHES & BANDOLIER*

The GLH (Grenade Launcher Holster) Pack was designed to provide the end user a ready to go bag for the HK GLM/M320 Grenade Launcher. Securing the weapon system in place along with eighteen 40mm rounds inside the pack with protection from the elements.

For zip-on configuration to match a specific carrier contact [sales@sandsprecision.com](mailto:sales@sandsprecision.com)

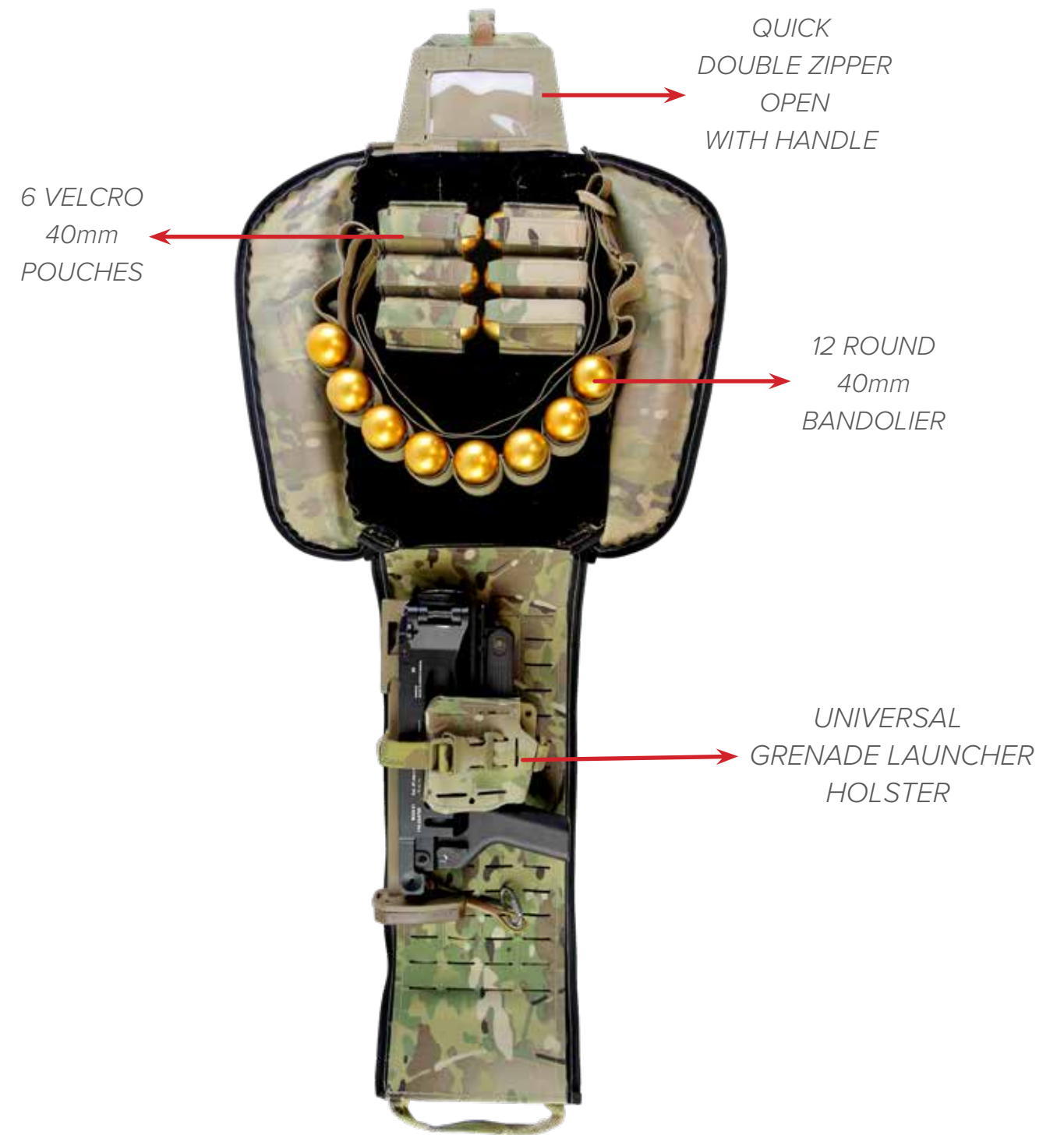

.....ADAPTS TO ANY USER'S APPLICATION.....

# Pouches and Accessories



## LOADOUTS

### Chest Mounted



FLIPLITE™ 02

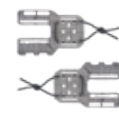

PTT WING  
3.0  
(SET OF 2)

### Center Frame



SINGLE  
9MM  
POUCH



DOUBLE  
9MM  
POUCH



TRIPLE  
M4  
POUCH



SMOKE  
GRENADE  
POUCH



RADIO  
POUCH



HALF RAPID  
ATTACHMENT (RAP)  
PANEL



FRAG  
POUCH



TRIPLE  
40MM  
POUCH



SINGLE  
40MM  
POUCH



UTILITY  
POUCH



VERTICAL  
UTILITY  
POUCH

### Abdominal



DEEP 6  
ACCESSORY POUCH



MOLLE HANGER-HORIZONTAL



TOURNIQUET  
POUCH  
(Tourniquet not included)

### Load Bearing Wing & Cummerbund



SINGLE  
9MM  
POUCH



DOUBLE  
9MM  
POUCH



IZLID®  
QUICK-DRAW  
POUCH



SMOKE  
GRENADE  
POUCH



RADIO  
POUCH



FRAG  
POUCH



TRIPLE  
40MM  
POUCH



SINGLE  
40MM  
POUCH



VERTICAL  
UTILITY  
POUCH



UTILITY  
POUCH



DUMP  
POUCH

### Back



HYDRATION POUCH



VERTICAL  
UTILITY  
POUCH



UTILITY  
POUCH



FULL RAPID  
ATTACHMENT  
PANEL



DUMP  
POUCH

[Table of Contents](#)

A close-up photograph of a soldier's torso and arm. The soldier is wearing a multi-colored camouflage uniform. A rifle is slung over their shoulder, with a magazine and a magazine well cover visible. The soldier's right hand is wearing a blue, textured tactical glove. The background is a solid, dark green color.

# EBELT SYSTEMS

Adapters & Accessories



## EVERYDAY CARRY (EDC) BELT



- Rigid and stable belt for your Everyday Carry needs (OWB/IWB Holster, Edged Weapon, Covert Carry Accessories).
- Double layer 38mm (1.49" height) webbing wrapped with external loop Velcro field for attachment to additional gun belt system.
- Reversible buckle – remove and flip the female buckle to present the webbing side to the outside.
- Low profile stainless steel and aluminum side release buckle that easily passes through common belt loops (47mm/1.85" height).
- Compatible with all 1.5" (height) attachment clips.
- WARNING: This is not intended for climbing.



See sizing chart online.

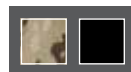

## 9MM POUCH WITH SPRING TENSIONER

- Rigid magazine pouch
- Reinforced leading edge of pouch maintains open position.
- Comes with removable tension spring. Flip spring for tension at the top or bottom of pouch.
- Compatible with MOLLE/PALS system.
- Compatible with steel and polymer 9mm magazines.



## ELOS™ BELT ADAPTER

- Bolt on Belt Adapter for the ELOS™ 556 magazine box.
- Simply wrap the adapter around your Battle Belt and lock down the position with Velcro.
- Velcro mates with Battle Belt internal hook and EDC Belt outer loop Velcro.

## BATTLE BELT

- Rigid and stable gun belt platform for tactical accessories (Holster System, Mag Pouches, IFAK/tourniquet, etc.).
- Reinforced platform with internal field of hook Velcro and external field of laser cut MOLLE/PALS compatible slots.
- Adjustable sizing with low profile stainless steel and aluminum side release buckle.
- WARNING: This is not intended for climbing.

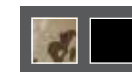

See sizing chart online.

## HOLSTER ANCHOR

The Holster Anchor inserts into MOLLE/PALS field, folds back over the belt and routes through the GRT™ Reinforced Belt Adapter to prevent slipping/movement.

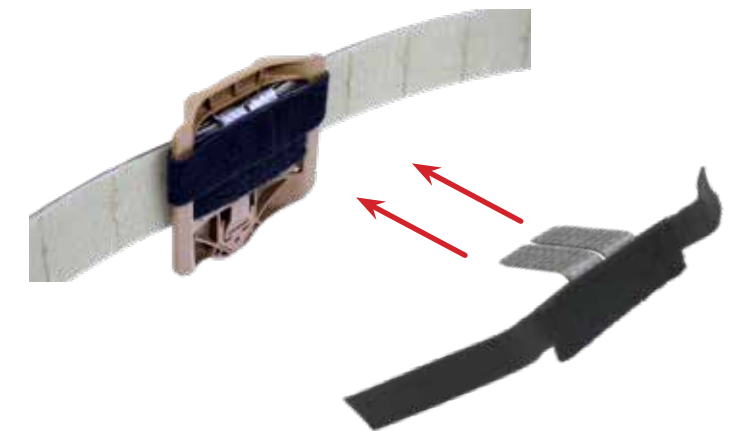



**RETENTION  
SYSTEMS**

Gear & Weapon Accessories

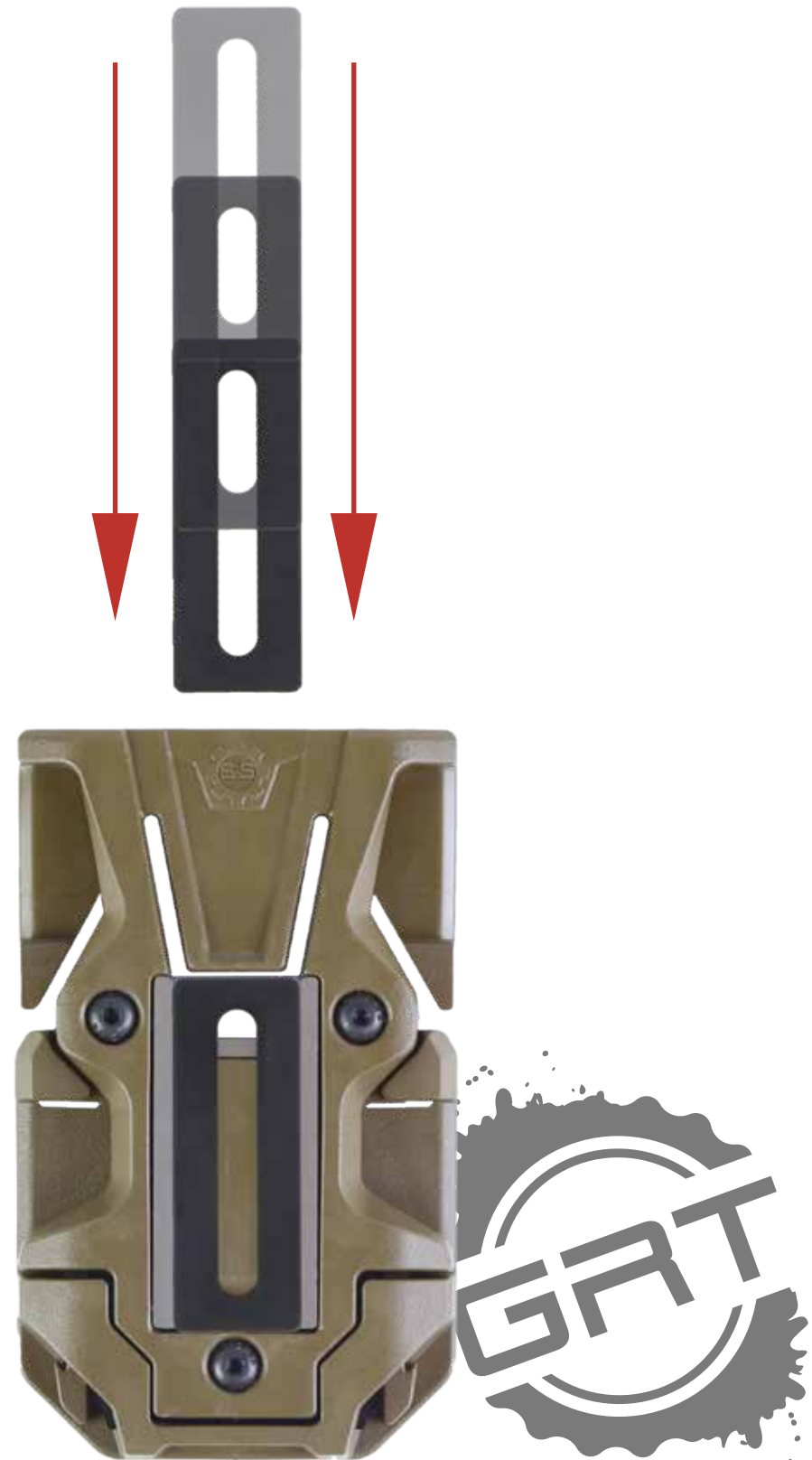

**PISTOL RETENTION**



**RIFLE RETENTION**



**GRENADE LAUNCHER RETENTION**



**MAG RETENTION**







## GRT™ BELT ADAPTER

The GRT™ Belt Adapter provides a waist attachment platform for GRT™ accessories. Includes the Multi-Belt Stabilizer which allows the adapter to fit a variety of belt sizes.

- Fits standard belt sizes: 1½", 1¾", & 2"
- Weight: 5.82 oz
- Patent #: US 10238201
- NSN Available -  
See NSN Index page 65.



## GRT™ WEBBING ADAPTER

The GRT™ Webbing Adapter provides a MOLLE/PALS compatible attachment platform for GRT™ accessories.

- MOLLE/PALS compatible adapter
- Occupies two columns and two rows of webbing
- Weight: 1.60 oz
- Patent #: US 10238201



## ELOS™ 5.56

The ELOS™ 5.56 is a rugged, virtually indestructible, flexible magazine holster.

- Injection molded elastomer
- Tear, crack, and weather resistant
- Low noise signature
- GRT™ adapter included
- Fits standard 5.56 magazines
- Stackable in parallel or vertical offset positions
- 2 mounting options: GRT Adapter kit OR ELOS Belt Adapter
- Hydrophobic
- Drain holes
- Weight: 2.91 oz
- Patent #: US 10238201



## SKELETONIZED MAGAZINE RETENTION™ (SMR™)

- Rigid magazine holder
- GRT™ compatible
- Fits standard 5.56 magazines
- Hydrophobic
- SMR™ weight: 1.4 oz
- Patent #: US 10238201

## SMR™ DUST-E™

The SMR™ Dust-E™ ensures that dust and foreign particles do not compromise magazine function.

Dust-E™ weight: 1.0 oz



## GRT™ ADAPTER KIT

The Adapter Kit converts soft pouches and other equipment to the GRT™ modular system. Includes: the GRT™ Adapter with 3 sets of screws and a set of binding posts.



GRT™ ELOS™ 5.56  
PlateFrame Kit



GRT™ SMR  
PlateFrame Kit



### HOLSTER EXTENDER™

- The Holster Extender™ allows the holster to be easily attached or removed from different gear setups utilizing any GRT™ platform
- Lightweight design and smooth operation
- With a push of a button the Holster Extender™ gives the shooter three set drop positions to set their holster. (0", 1 ½", and 3"). This distance can be critical for clearing the holster when wearing bulkier gear
- Compatible with most holster brands
- Includes: GRT™ Reinforced Belt adapter, spacers, and screw kit to set the standoff to optimize your holster carry and draw
- Patent #: US 10238201



### HOLSTER ADAPTER PLATE

- The Holster Adapter Plate Allows users to set the holster's angle (+/- 10 degrees)
- Provides users with the ability to switch holsters from vertical to angled and angled to vertical
- Mounts via the Gear Retention Track
- Includes the GRT Adapter Kit, Spacers, and screw kit to optimize holster carry and draw
- Can be used in conjunction with the Holster Extender to cancel out angle
- Patent #: US 10238201



The HAP is the interface between the holster and GRT™ Adapter.

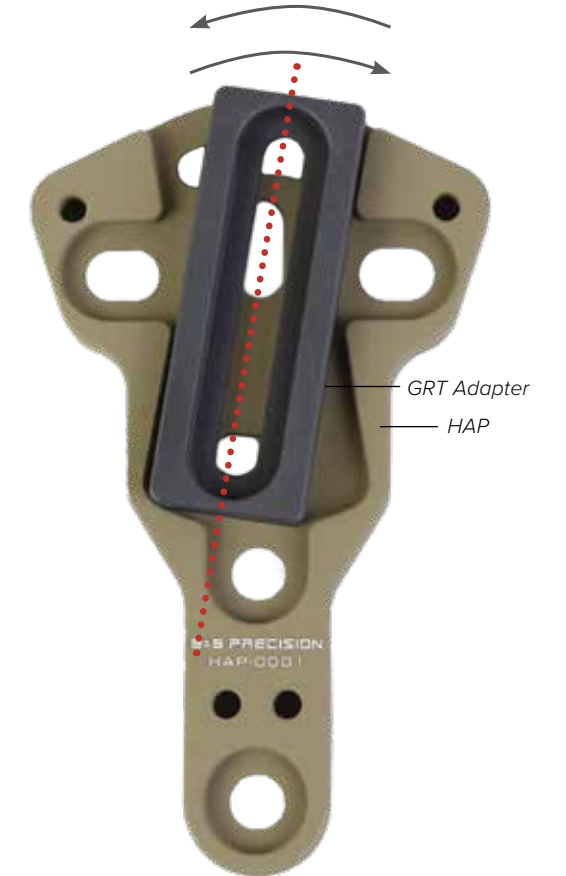

### USER CONFIGURATIONS

#### THREE SET DROP POSITIONS

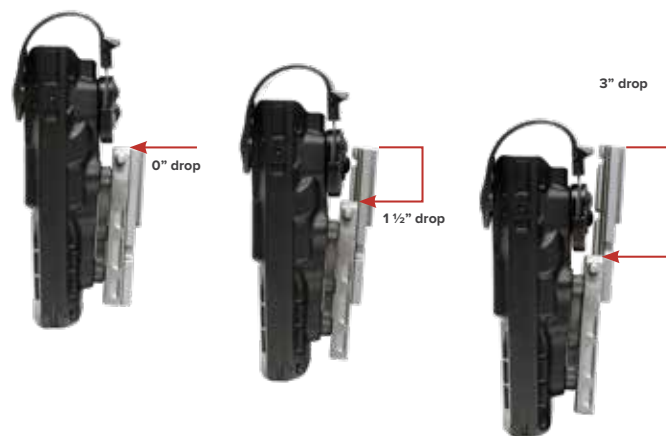

Vertical to Angled



Angled to Vertical





The S&S Precision WeaponLink™ has been consolidated into a single design utilizing the GRT™ system for modularity with the reinforced webbing or belt adapters. The WeaponLink™ consists of two pieces; one being the male that attaches to the rifle and the female that locks into the GRT track adapter.

- Zero weapon rotation
- Optimized for hands-free work
- Rigid and vertically stable weapon orientation
- Broad receiver opening for faster placement
- Lower profile rail grabber with single bolt clamping
- Enhanced rail grabber profile for hand stop/positioning along the rail system
- Spring ball material is wear-resistant polymer, reducing material stress over time and reduced audible snap
- Available with GRT™ Reinforced Belt Adapter or GRT™ Reinforced Webbing Adapter
- Snag-free design
- Compatible with 1913 Picatinny rail
- Patent #: US 8166694, US 10238201
- NSN Available - See NSN Index page 65



- Designed to fit most standard 1" slings
- Sleek design offers versatility without bulkiness
- Effectively turns your single point sling into a two point sling with a simple flick of your thumb
- 6061 aluminum
- Integrated hand stop/finger groove
- Skeletonized low-profile design with fewer components
- Fits standard Picatinny rail systems: Keymod™ and M-LOK® versions available
- Works in conjunction with single point sling systems (1" width) to secure weapon
- Patent #: US 8650794



PICATINNY



M-LOK®



Keymod™



KEYMOD SHOWN

## LOW PROFILE SLING

- Free floating snap hook wrapped with bungee silencer
- Ladder Lock mechanism adjustment with stretch sleeve cover
- 1" flat webbing
- Size: Adjustable



## CONFIGURATION: SINGLE POINT SLING (TWO POINT WHEN USING S&S PRECISION SLINGCLIP™)



SINGLE POINT

TWO POINT



Open face design

## UNIVERSAL GRENADE LAUNCHER HOLSTER

The Universal Grenade Launcher Holster (GLH-U) is designed specifically to secure and maintain the HK GLM/M320 Grenade Launcher. Due to the holster's open face design, the weapon can be easily holstered and rapidly drawn without reconfiguring the weapon. The weapon is retained via a thermoformed clamp that snaps around the trigger guard, an adjustable retention strap which prevents the weapon from disengaging the clamp, and an optional adjustable sling that can be secured to the user's plate carrier. The GLH-U can mount to MOLLE/PALS and is also compatible with S&S Precision's GRT system; GRT reinforced webbing adapter included. Utilizing S&S Precision's GRT system allows the user to rapidly transition the holster from a MOLLE/PALS platform to a belt. The GLH-U is an ambidextrous system and can easily be configured for either right or left hand carry.

- Patent #: US 10238201

**COMPATIBLE WITH  
HK GLM/M320 GRENADE LAUNCHER**



## SLING & GRT™ MOUNTING KIT INCLUDED:



GRT™ Reinforced Webbing Adapter

GRT™ Adapter

GRT™ Adapter Panel

Sling



COMPATIBLE WITH  
HK GLM/M320 GRENADE LAUNCHER

## LAUNCHER MOUNTS & ACCESSORIES

These mounts allow the operator to accessorize the HK GLM/M320 with laser systems and red dot optics while maintaining the ability to collapse a full length buttstock underneath the base mount. Specifically designed to reduce material weight and overall size.



## LAAW CLIP™

The LAAW Clip™ is a simple way to carry a M72 LAW (Light Anti-armor Weapon) Rocket Launcher in a vertical position on your back. The LAAW Clip™ is mounted via the MOLLE/PALS webbing system.

- Allows users to carry a LAAW rocket on their back
- Rigid vertical orientation
- Zero weapon rotation
- Attaches to MOLLE/PALS webbing using 1" webbing straps



[Table of Contents](#)

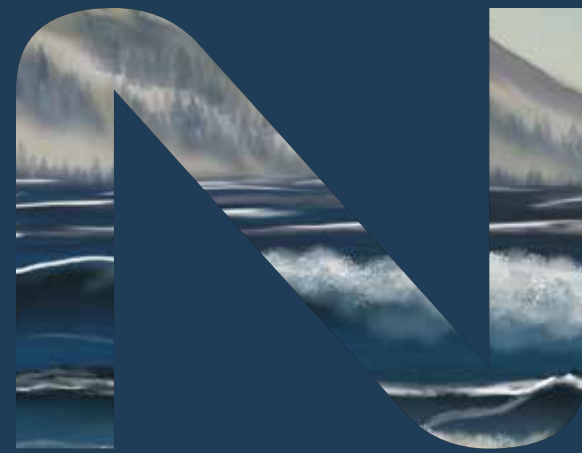

**AVGEAR**

Navigation & Accessories



- Enhanced durability and performance
- Molded with impact modified Nylon
- Case agnostic - fits smart devices up to 3.5" W x 6.75" L x 0.6875" D with or without case
- Enables users to utilize their preferred case
- Adjustable friction hinge
- Silicone smart device retention straps featuring internal ribbing to prevent the straps from peeling off the user's smart device
- Bungee lock auto-stows out of the way and does not interfere while using a smart device
- Attaches to 4 x 2 MOLLE/PALS field via two mounting straps
- Rapid donning / doffing
- Integrated belly band slots
- Patents Pending Foreign & Domestic



## NAVBOARD®FLAP 2.0



- The new generation in the FlipLite™ Accessory Pack, compatible with the NEW NavBoard FlipLite™
- FLAP 2.0 Pack includes GPS panel, compass panel and your choice of Oceanic or Suunto Compass



\*Optional Weather Jacket\*



## FLIPLITE™ EXTENDER

The Fliplite Extender allows for the end user device to be extended out for a better view of the screen while wearing O2 masks during free fall operations



## FLIPLITE™ HEIGHT ADJUSTER

The Fliplite Height Adjuster allows for control of how high or low the FlipLite sits chest mounted on carriers or harnesses. The EUD will fold open to a 90 degree angle, and helps clean up the area above the magazines

## USER CONFIGURATIONS

### ON NAVBOARD® FLIPLITE™ HARNESS

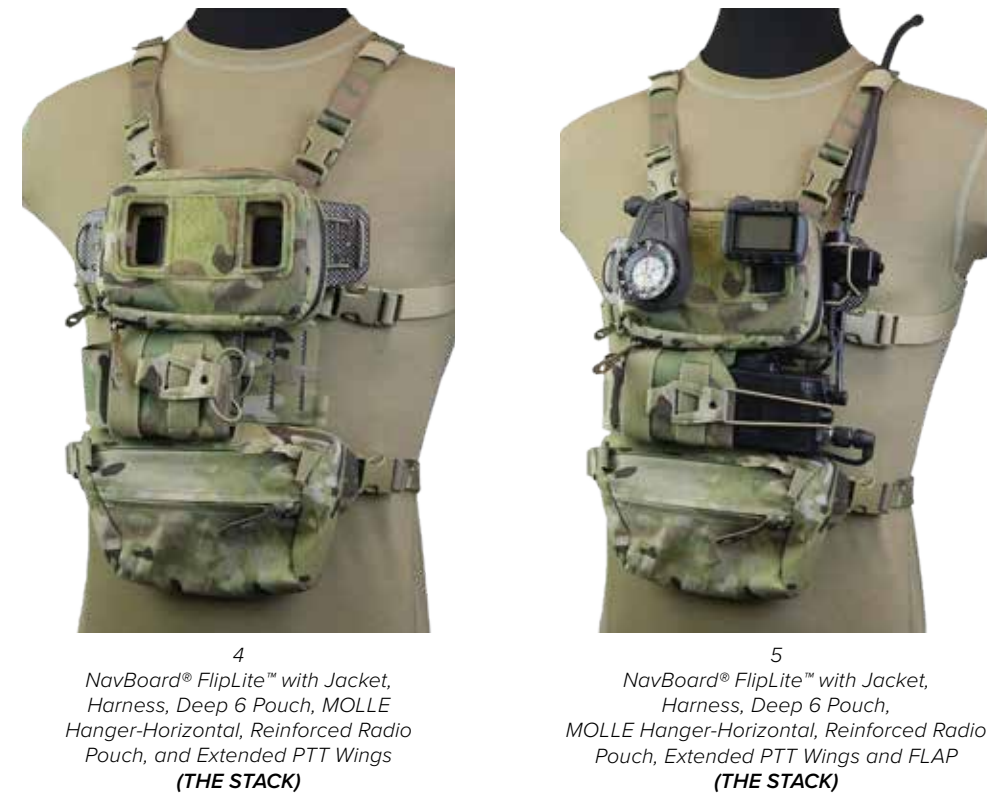





The NavBoard® Rotary allows users to attach a wide range of consumer electronic navigation devices, with or without a protective case. It can be stowed close to the user's body, deployed in an open position and viewed in either a vertical or horizontal configuration. When stowed in vertical position the NavBoard® Rotary requires only 2 columns and 4 rows of webbing.

- Hands-free navigation
- Flip-down large panel (7" x 3.625") is designed to fit plus size smart devices
- New features include camera window, integrated cleat, and rotating panel lock

## ROTATES FOR VERTICAL OR HORIZONTAL VIEWING



## FLIPMOD™

The FlipMod™ is now available in a fixed horizontal orientation while allowing the GPS/altimeter panel to be reconfigured using an adjustable friction hinge to fit the user's preference. It can be stowed close to the user's body when in free-fall or deployed in an open position.

- Low profile, compact design
- Provides hands-free navigation
- Modular design and orientation
- Flip-down large panel (6.875" x 5") is designed to fit plus size smart devices
- Optional spacer included to accommodate thicker devices
- Suunto (no bezel) or Oceanic (bezel) compass options available
- Patent #: US 10238201



GRT™ Belt and Webbing adapters included



## O2D2™

- Allows user to pre-breathe without wearing a helmet
- Combination of 4-way stretch and breathable mesh
- Small/Medium and Large/X-Large available



Right side features a quick release buckle

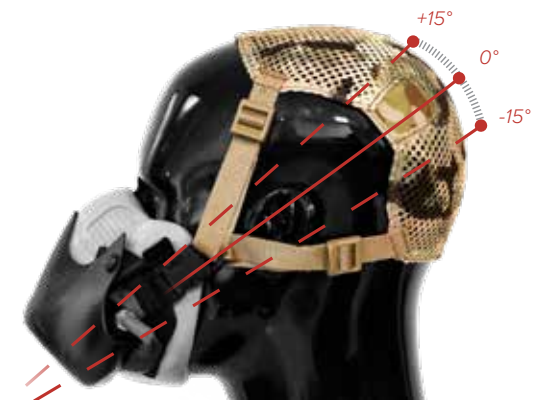

## COMPATIBLE MASKS

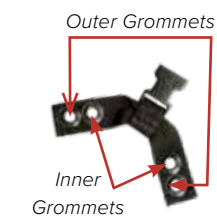

Left buckle shown

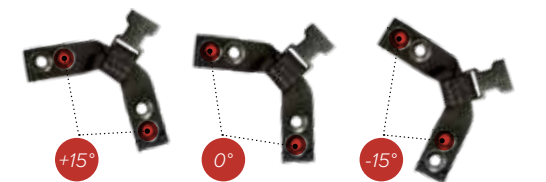

Attach the mask buckle using variations of inner/outer grommets to adjust mask in 15 degree increments.

[Table of Contents](#)



# PRECISION

OEM Capabilities & NSN Index

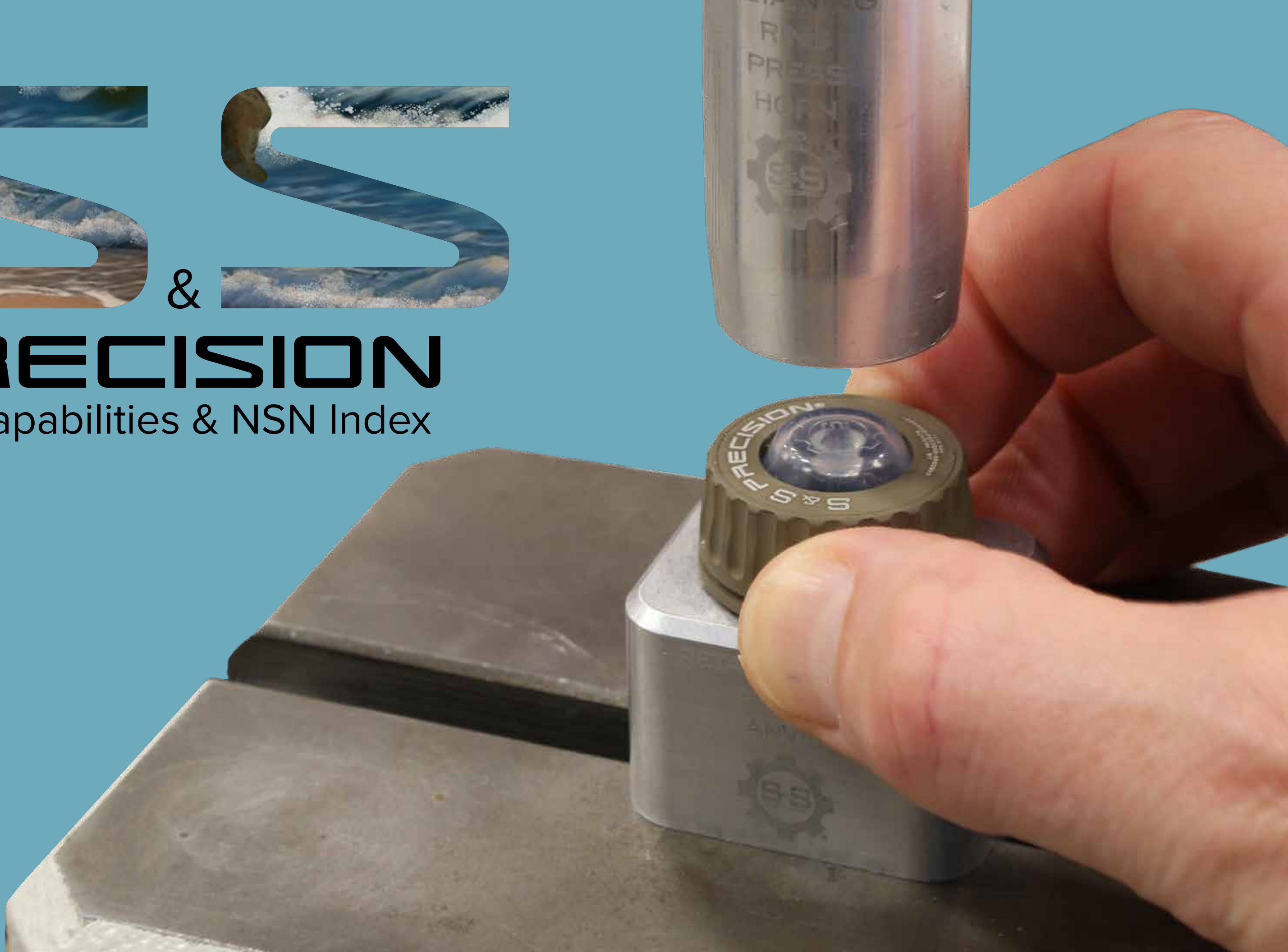

# OEM Capabilities

Team S&S understands the challenges of bringing concepts from paper to reality. Therefore, we offer our services to other small businesses that need help. We have invested significantly in our own manufacturing capabilities, to include; a diverse and creative design/engineering team, in-house mold design & manufacturing, injection molding presses, CNC machines and a number of other processes to get the job done.



## DESIGN & ENGINEERING

Product development services from conceptual design to production. Our engineering team specializes in injection molded parts, sheet metal, thermoforming, CNC machined parts, hybrid composites, and technical soft goods development.

## SEWING

S&S Precision's Sewing Department has over 50 years of tactical application sewing experience. We offer complete services from design and engineering to cutting, prototyping, and the final sewn production of goods.



## INJECTION MOLDING

Our design and development team create custom plastic injection molds, prototypes, and assist in troubleshooting part design. S&S Precision offers 20, 80, and 100 ton presses capable of superior stable molding repeatability.

## HYDRO DIP & CERAKOTE™

Our Hydro Dip (Water Transfer Printing) production operations delivers a wide variety of commercial and licensed design options for Commercial, Government, Military, and Law Enforcement Agencies. Our in-house Cerakote™ and oven curing services offer a wide range of finishing solutions for firearms, metals, plastics, weapon accessories, knives, helmets, and specialized proprietary projects.



## MACHINING

With multiple in-house mills and lathes, S&S Precision is fully capable of machining a variety of parts from plastic to titanium. Our machine shop can produce multiple pieces to completion within one operation via multi-axis systems, resulting in higher productivity and reduced cost to our clients.

## LASER ENGRAVING

Our facility is equipped with three laser machines to handle engraving projects and heavy-duty material cutting managed by a team of laser technicians, engineers, and graphic designers. Material capabilities include paper, leather, fabrics, wood, hard plastics, and a variety of metals.



## PLATEFRAME & ACCESSORIES/COMPONENTS

PFP-RPMC	PlateFrame, Radio Pouch-MultiCam	8465016312054
PFP-RPTV	PlateFrame, Radio Pouch-ToadVine	8465016312055
PFF-0001	PlateFrame Closed Cell Flotation (set)	8470016312056
PFP-2MPBLK	PlateFrame 5.56 2 Magazine Pouch-Black	8465016312061
PFP-2MPMC	PlateFrame 5.56 2 Magazine Pouch-MultiCam	8465016312063
PFP-BQSMC	PlateFrame Breaching Quiver, Single, MultiCam	8465016312085
PFP-BQSTV	PlateFrame Breaching Quiver, Single, ToadVine	8465016312086
PFP-FPMC	PlateFrame Frag Pouch, MultiCam	8465016312089
PFP-FPTV	PlateFrame Frag Pouch, ToadVine	8465016312090
PFP-HP70MC	PlateFrame Hydration Pouch 70oz, MultiCam	8465016312096
PFP-HP70TV	PlateFrame Hydration Pouch 70 oz, ToadVine	8465016312098
PFS-S001MC	PlateFrame, SOCS-MultiCam	8470016312405
PFS-S001TV	PlateFrame SOCS-ToadVine	8470016312407
PFP-SGPMC	PlateFrame Smoke Grenade Pouch, MultiCam	8465016312409
PFP-SGPTV	PlateFrame Smoke Grenade Pouch, ToadVine	8465016312411
PFP-SPPMC	PlateFrame, Side Plate Pouch-MultiCam	8470016312416
PFP-SPPTV	PlateFrame, Side Plate Pouch-ToadVine	8470016312419
PFP-UPMC	PlateFrame Utility Pouch-MultiCam	8465016312422
PF-T001.2BLK	PlateFrame, Tactical - Black LG/XL Harness Assembly (Large Plate)	8470016312428
PF-T001.1BLK	PlateFrame, Tactical - Black SM/MD Harness Assembly (Medium Plate)	8470016312430
PFP-UPTV	PlateFrame Utility Pouch-ToadVine	8465016312427
PF-T001.1BLK	PlateFrame, Tactical- Black SM/MD Harness Assembly (Small Plate)	8470016312434
PF-T001.2BLK	PlateFrame, Tactical- Black LG/XL Harness Assembly (XL Plate)	8470016312436
PF-T001.2TV/MC	PlateFrame, Tactical - ToadVine with LG/XL MultiCam Harness Assembly (Large Plate)	8470016312437
PF-T001.1TV/MC	PlateFrame, Tactical - ToadVine with SM/MD MultiCam Harness Assembly (Medium Plate)	8470016312439
PF-T001.1TV/MC	PlateFrame, Tactical - ToadVine with SM/MD MultiCam Harness Assembly (Small Plate)	8470016312441
PF-T001.2TV/MC	PlateFrame, Tactical - ToadVine with LG/XL MultiCam Harness Assembly (XL Plate)	8470016312443
PF-SS(Set)MC	PlateFrame - Right and Left Shoulder Strap, MultiCam	8470016337231
PF-CB(Set)S.TV	One Left Cumberbund Strap and One Right Cumberbund Strap in ToadVine in Small	8470016337267
PF-CB(SET)S.MC	One Right Cumberbund Strap and One Left Cumberbund Strap in MultiCam in Small	8470016337270
PF-CB(Set)TV	PlateFrame - Right and Left Cumberbund Strap, ToadVine	8470016337275
PF-CB(Set)MC	PlateFrame - Right and Left Cumberbund Strap, MultiCam	8470016337278
PF-SS(Set)TV	PlateFrame - Right and Left Shoulder Strap, ToadVine	8470016337282
PFA-TPTV	PlateFrame Accessory, Tourniquet Pouch- ToadVine	8470016337285

## MANTA STROBE

MS-0011	Manta Strobe, Green Overt	6210016298285
MS-0015	Manta Strobe, IR Down/Up, Solid Green, Solid Green & White Strobe	6230016302690
MWA-0001	Manta Webbing Adapter	8470016337301

## V-LITE

VL-IR012V	V-Lite, Infrared On/Blink/Off w/Velcro	6230016065535
VL-R012V	V-Lite, Red On/Blink/Off w/Velcro	6230016287083
VL-G012V	V-Lite, Green On/Blink/Off w/Velcro	6230016287084

## GEAR RETENTION

SMR-BA001BLK	Gear Retention Track-Belt Adapter, Black	8470016337288
SMR-BA001TN	Gear Retention Track Belt Adapter, Tan	8470016337293

## WEAPONLINK

WL-M001	WeaponLink (MOLLE Version)	1005016292391
WL-B001	WeaponLink (Belt Version)	1005016296607



**COLOR KEY:**  
MultiCam; Toadvine; Coyote Tan;  
Coyote Brown; Black; Tactical Gray

Products available on:





757.453.6695 | [sandsprecision.com](https://sandsprecision.com)

2504 Squadron Court, Unit 110 | Virginia Beach, VA 23453



ssprecision



sandsprecision



S & S Precision

DEALER LOCATOR: [sandsprecision.com/store-locator](https://sandsprecision.com/store-locator)

[SANDSPRECISION.COM](https://SANDSPRECISION.COM)



S&S PRECISION'S  
Patent Information

[ssp-ip.com](https://ssp-ip.com)